

ConST610



让检测更轻松

.....



.....



- ◆
- ◆
- ◆
- ◆







					
					





拆箱准备

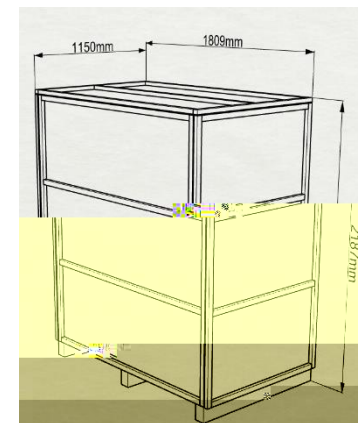

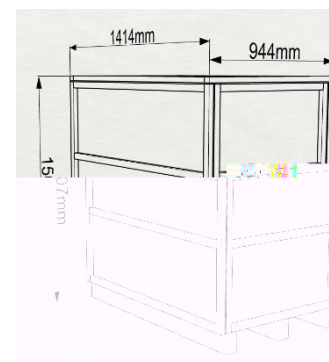
运输准备 (叉车、地牛1T载重起)

1. 准备工作
检查设备运输路径是否满足作业要求。检查路径上电梯口或门尺寸是否容纳设备通过。

注：
(1) 包装箱尺寸如右图所示：

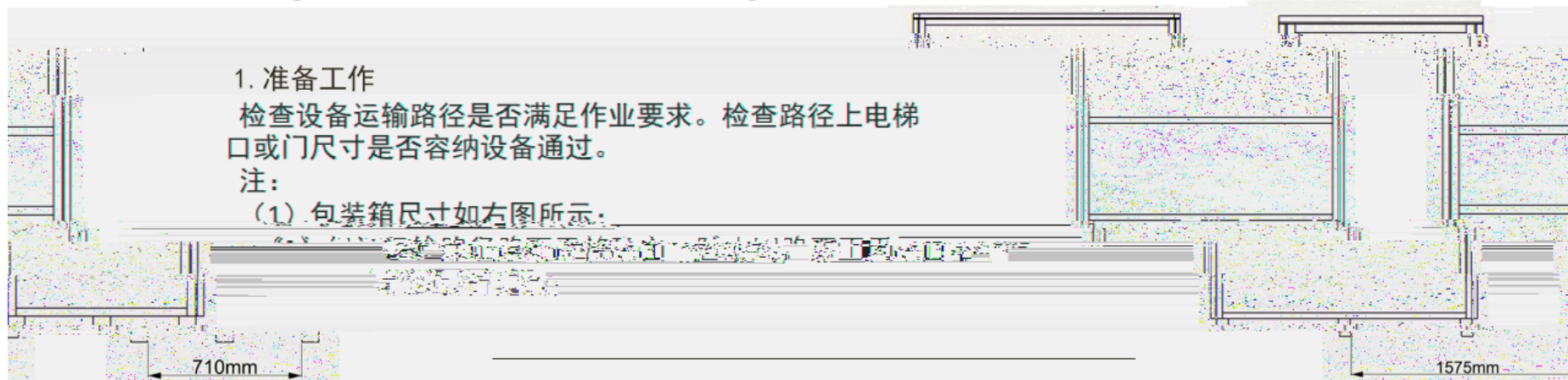

干气发生装置

2.1 利用叉车（吊车）卸车时，请充分考虑设备重量及体积。

2.2 设备拆箱时，需要利用叉车（吊车）将设备从运输底座上卸下。

2.3 使用人工液压搬运车（地牛）将设备转运至设备开箱区。

ConST610

电梯尺寸要求表

项目	ConST610	电梯
长 (mm)	1756	≥1800
宽 (mm)	940	≥1000
高 (mm)	1890	≥1900
重 (kg)	750	≥1000

备注：若电梯无法满足运输要求，需要使用吊车等机械设备上楼。

干气发生装置尺寸重量

尺寸(mm): 长 1240× 宽 770× 高 1240

重量: 260kg

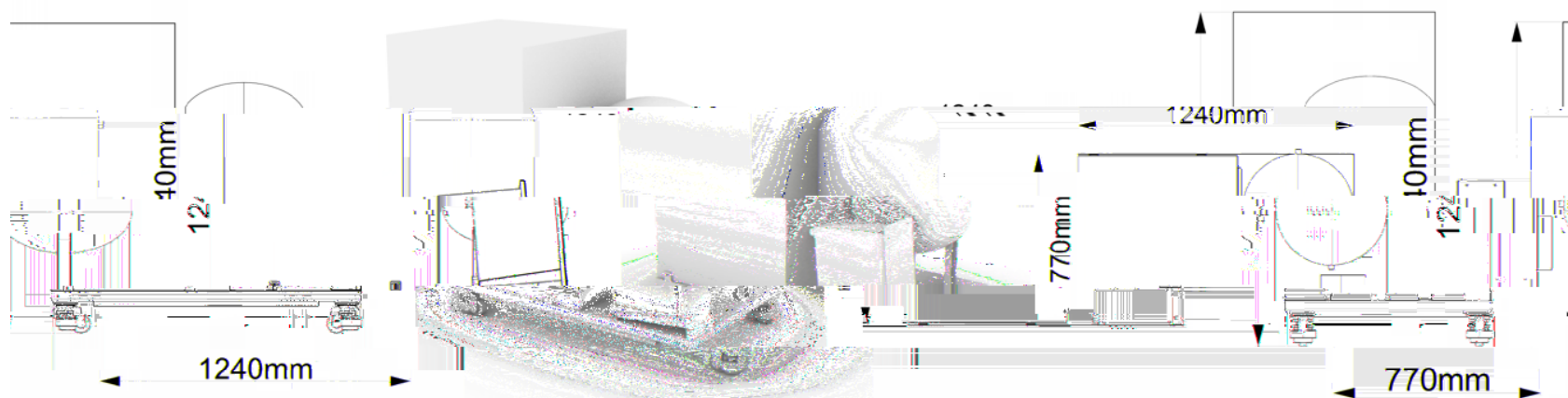

干气发生装置摆放平面图及环境要求

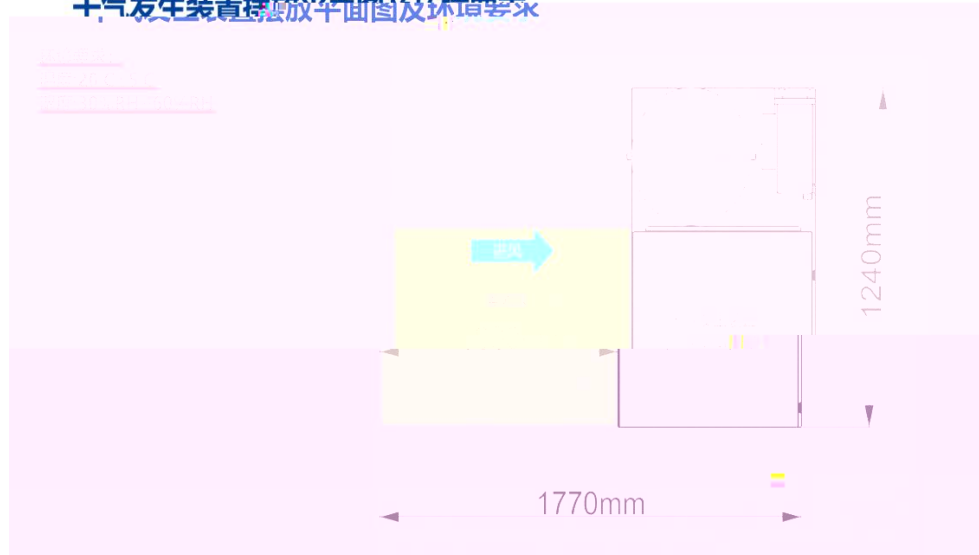

ConST610尺寸重量

尺寸(mm): 长 1756× 宽 1033× 高 1902

重量: 750kg

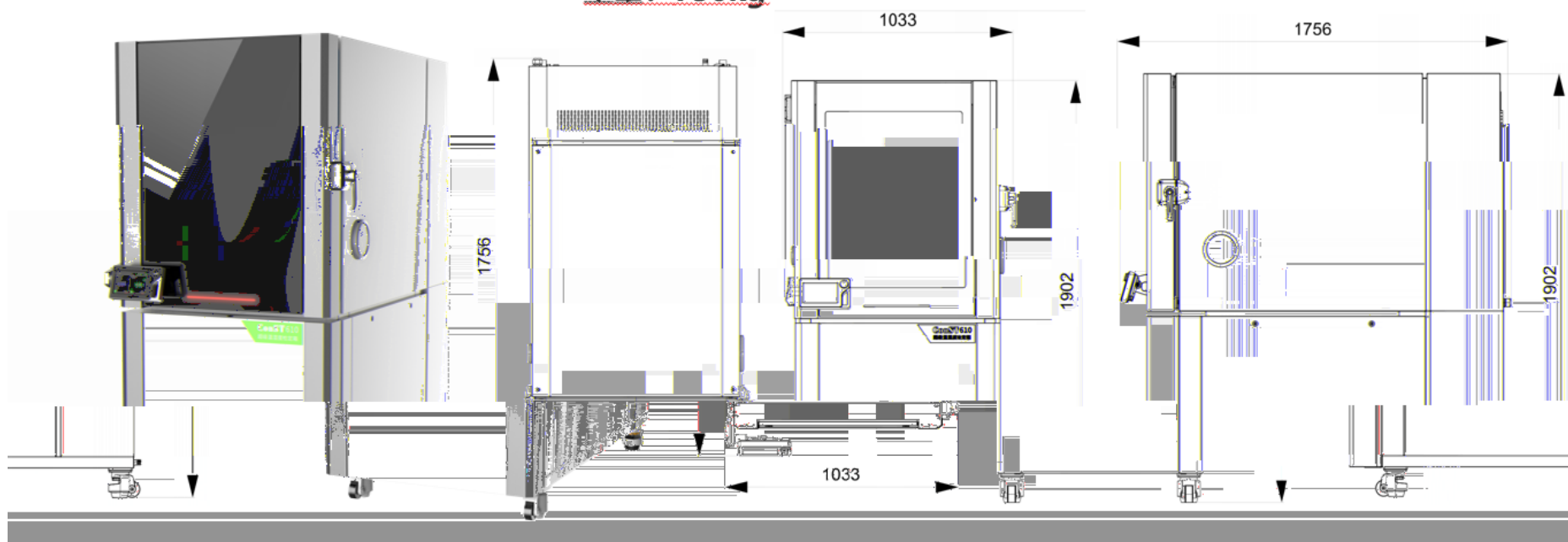

ConST610摆放平面图及环境要求

环境要求:
温度:20°C±5°C
湿度:30%RH~60%RH

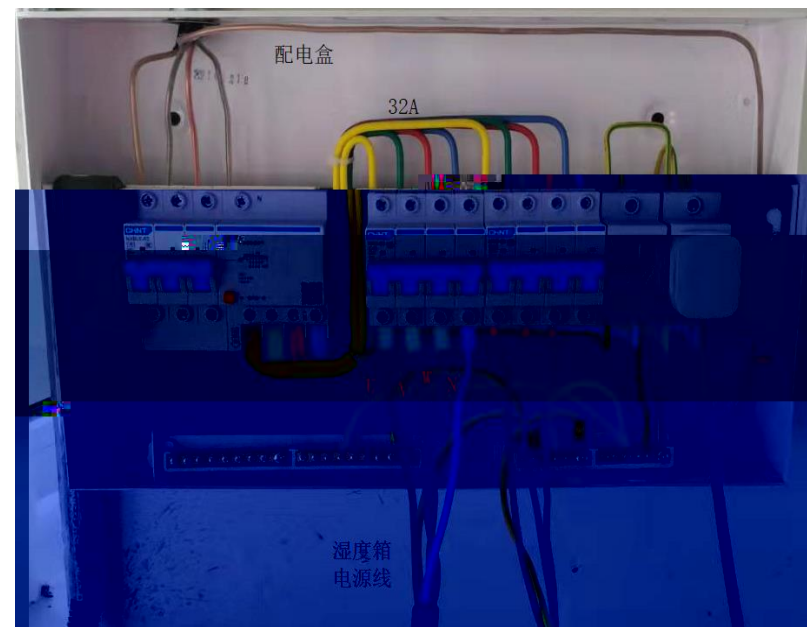
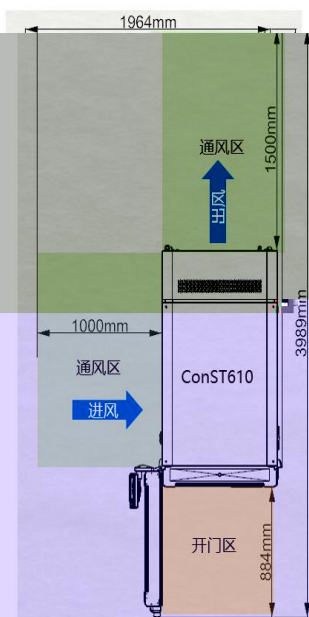





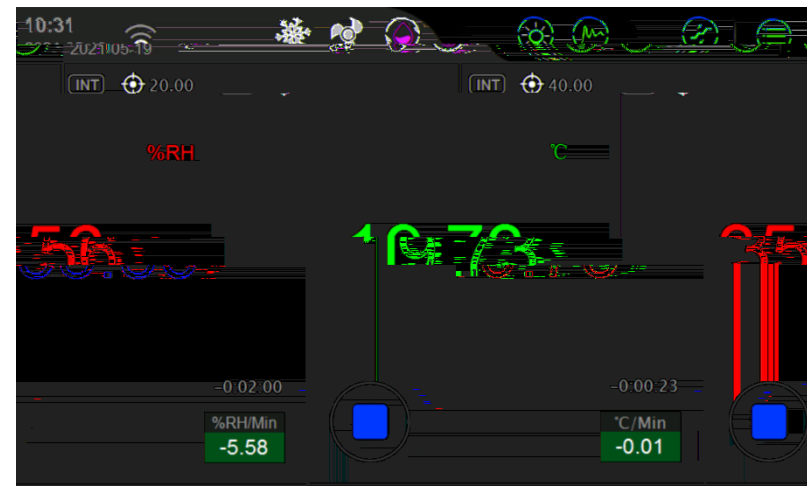
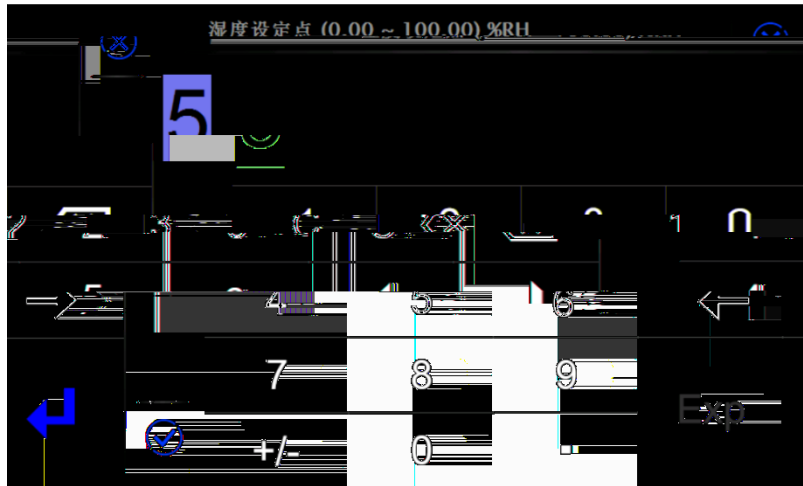

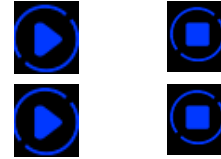

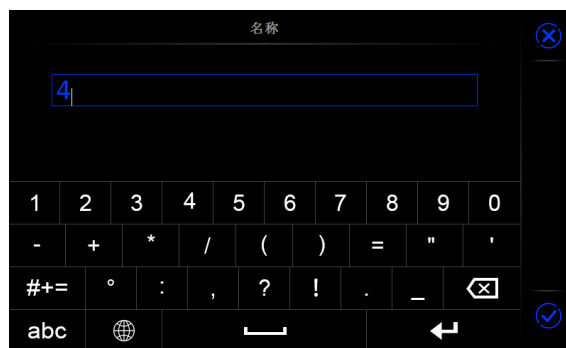
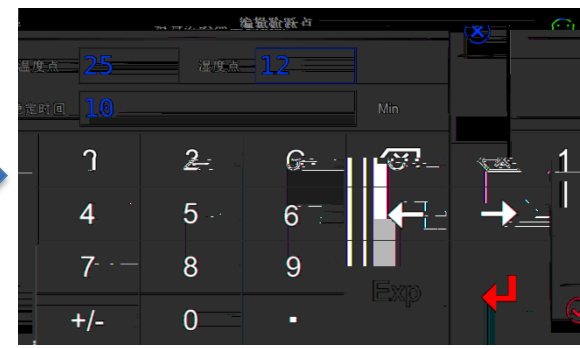
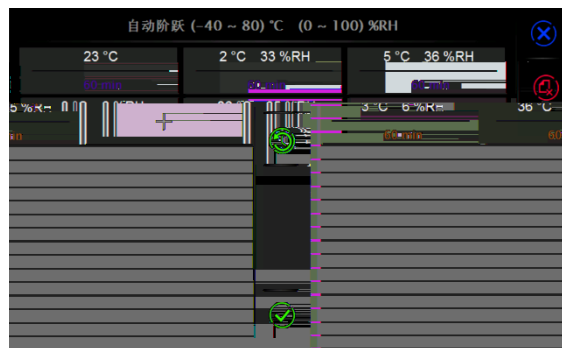
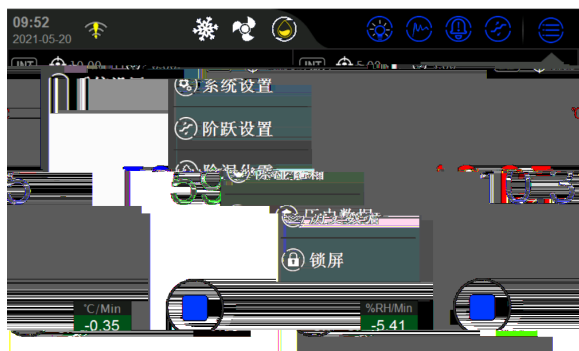

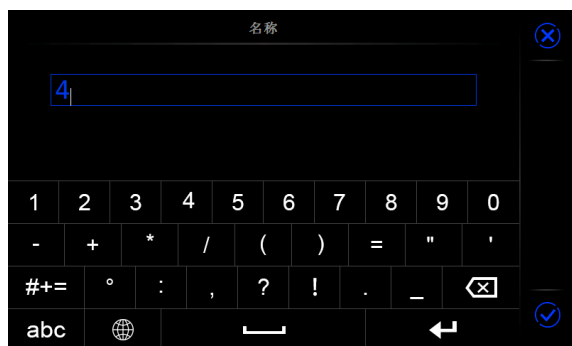
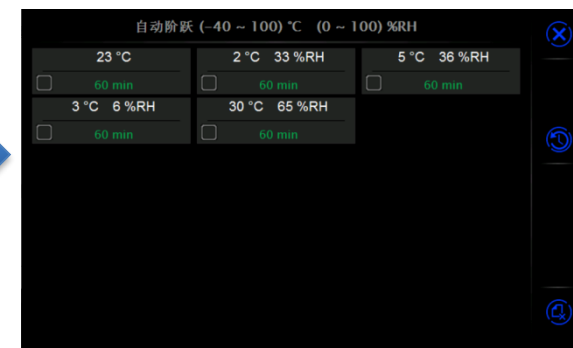
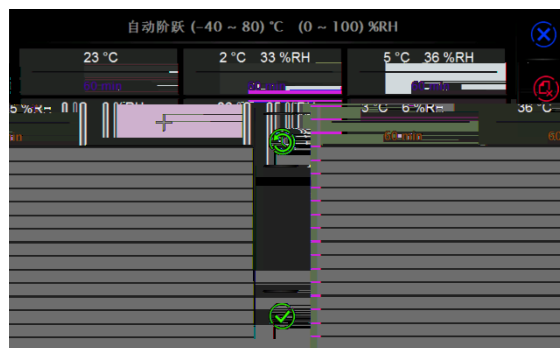

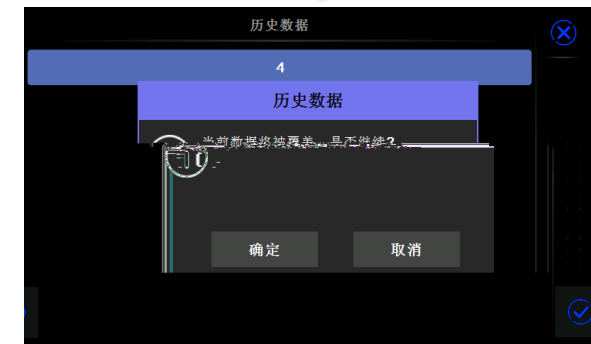
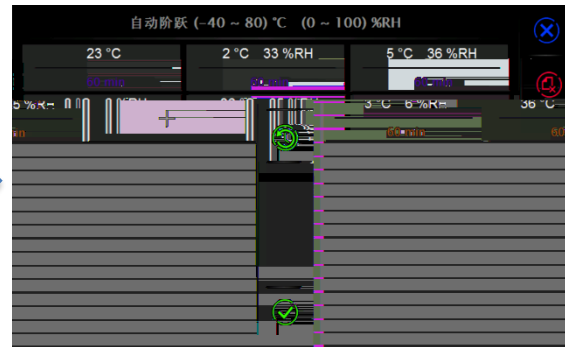





- 
- 
- 
- 

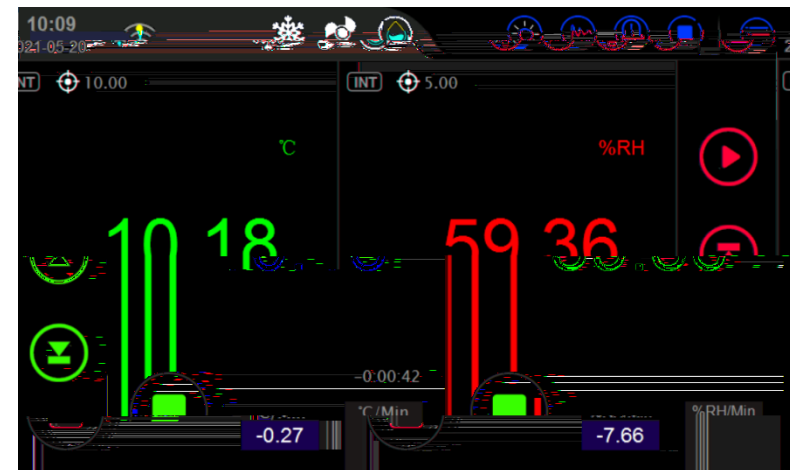
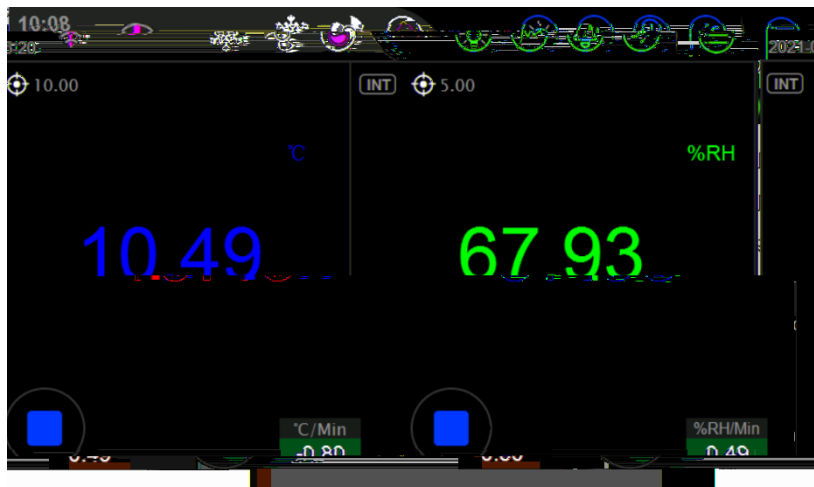

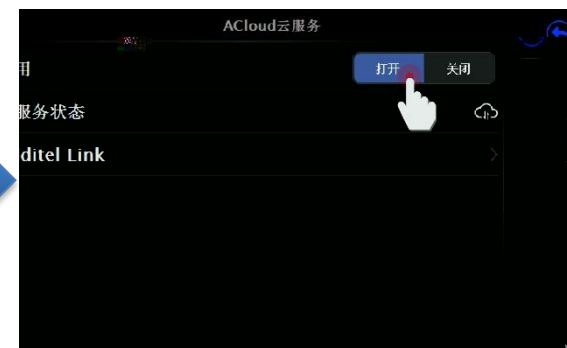
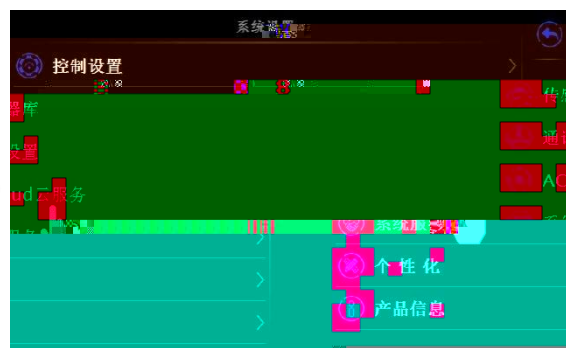

Additel Link

邮箱/用户名

密码

登录

语言 无法登录?

没有账号? [注册](#)



注册

注册

获取验证码

注册

已有账号? [登录](#)

邮箱

验证码

用户名

密码





-

-

-

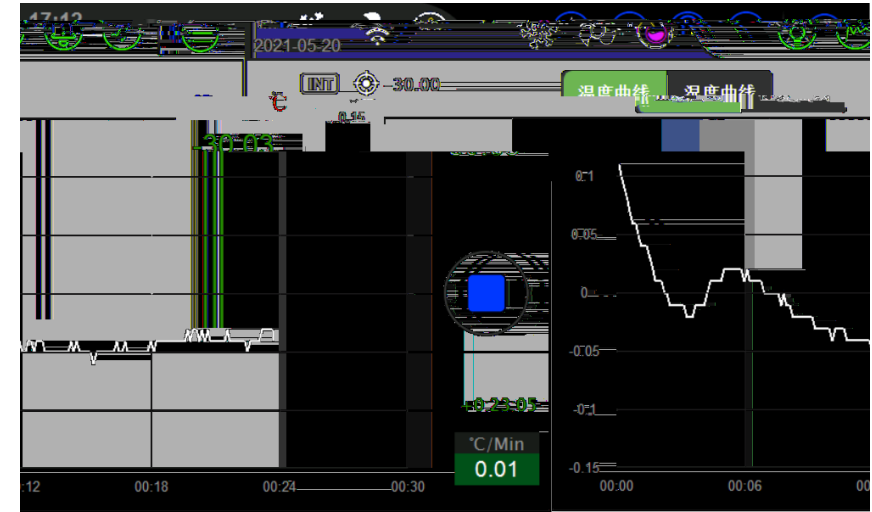
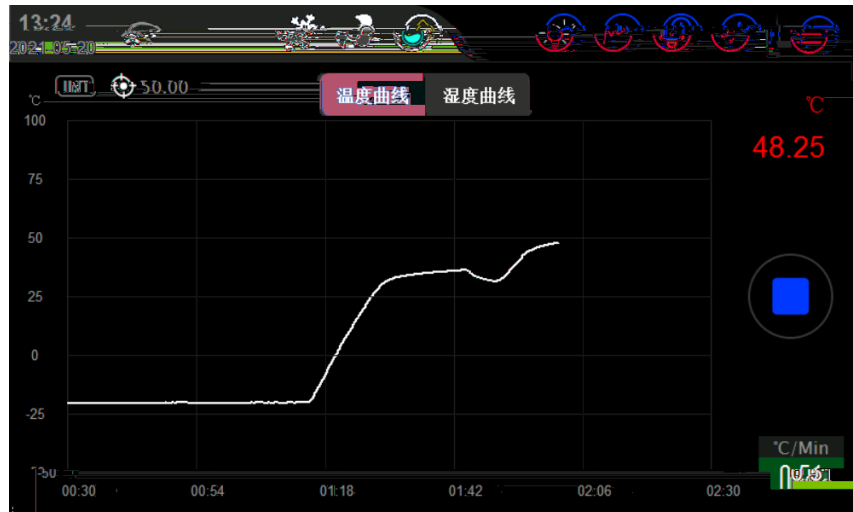

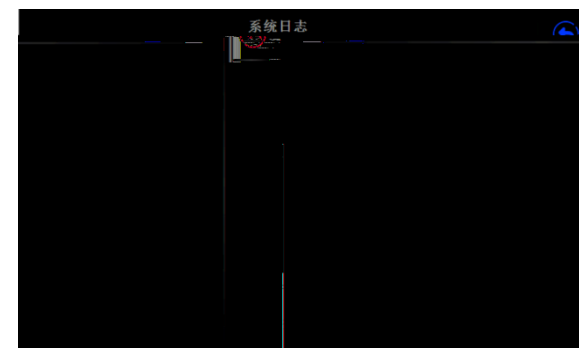
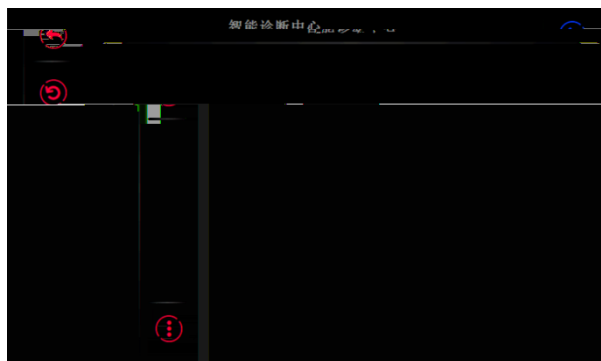

-
-
-





62



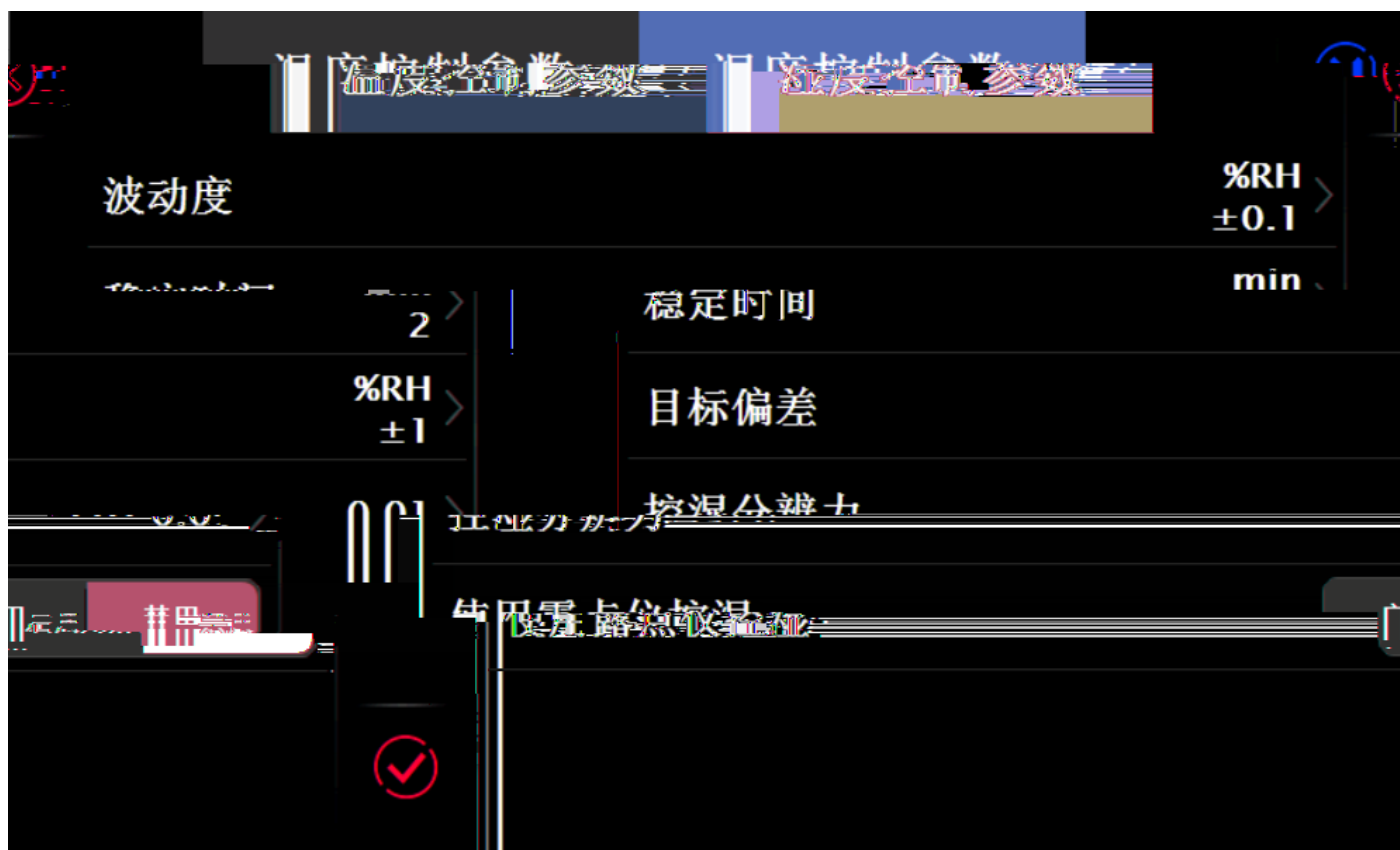



66

-
-
-
-



67





ACloud云服务

启用 打开 关闭

云服务状态

Additel Link

The image shows a dark-themed software interface for 'ACloud云服务'. At the top, there is a title bar with the text 'ACloud云服务' and a refresh icon on the right. Below the title bar, there is a section labeled '启用' (Enable) with two buttons: '打开' (Open) and '关闭' (Close). Underneath, there are two main items: '云服务状态' (Cloud Service Status) and 'Additel Link'. Each item has a small icon to its left: a cloud with a crossed-out circle for the status, and a right-pointing arrow for the link.







温度修正点

补偿点	补偿值
-40	0
-20	0
0	0
20	0
40	0
60	0
70	0

湿度修正点

补偿点 %RH	补偿值 %RH
5	1
17.86	2
30.71	3
43.57	4
56.43	5
69.29	6
82.14	7

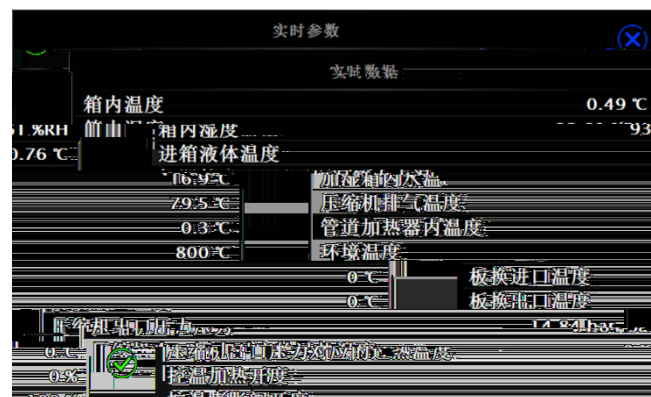

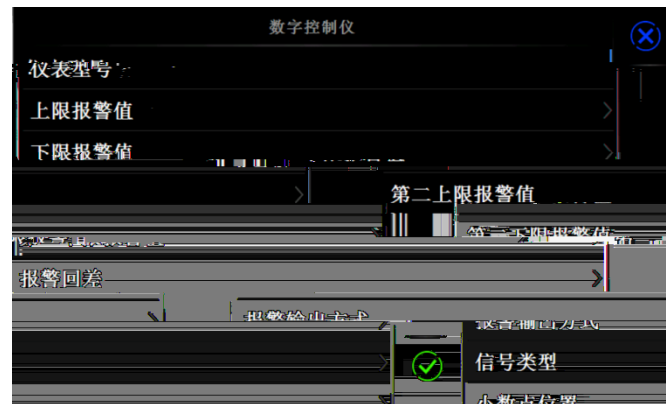
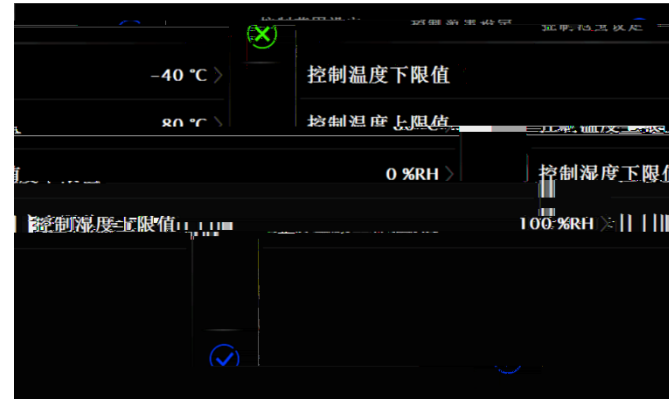

D D

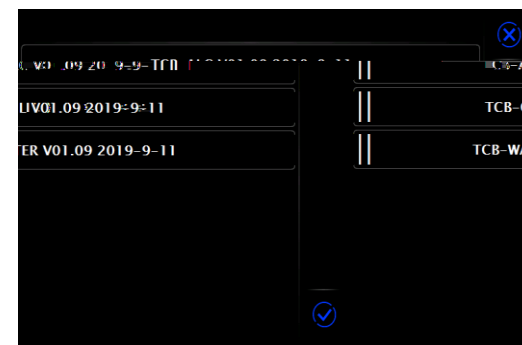

60

6 21





产品信息	
基本信息	
型号	ConST610
序列号	151522652
量程	(-40~80)°C (0~100)%RH
版本信息	
主程序	3.0.0.9
系统版本	33502 V00.00.00.01 W33502 V00.01
控制板	V3.48 V6.10.0

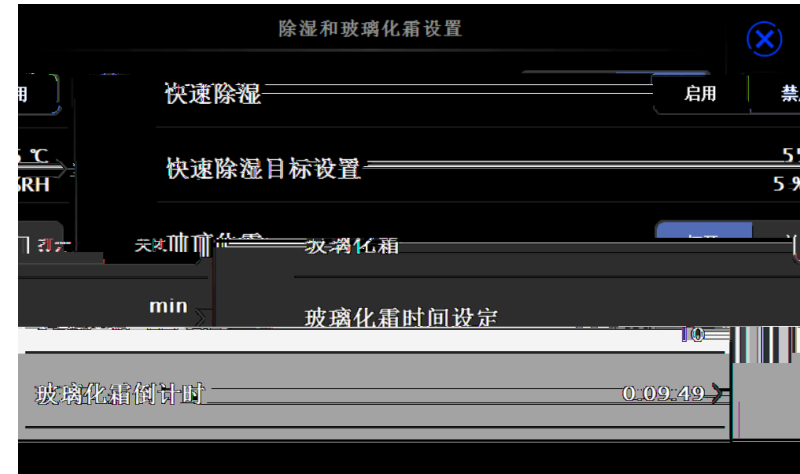

历史数据记录

	2021-04-30.csv
	2021-04-29.csv
	2021-04-28.csv
	2021-04-27.csv
7.csv	2021-04-26.csv
6.csv	2021-04-25.csv
5.csv	2021-04-24.csv
3.csv	2021-04-23.csv
2.csv	2021-04-22.csv
1.csv	2021-04-21.csv

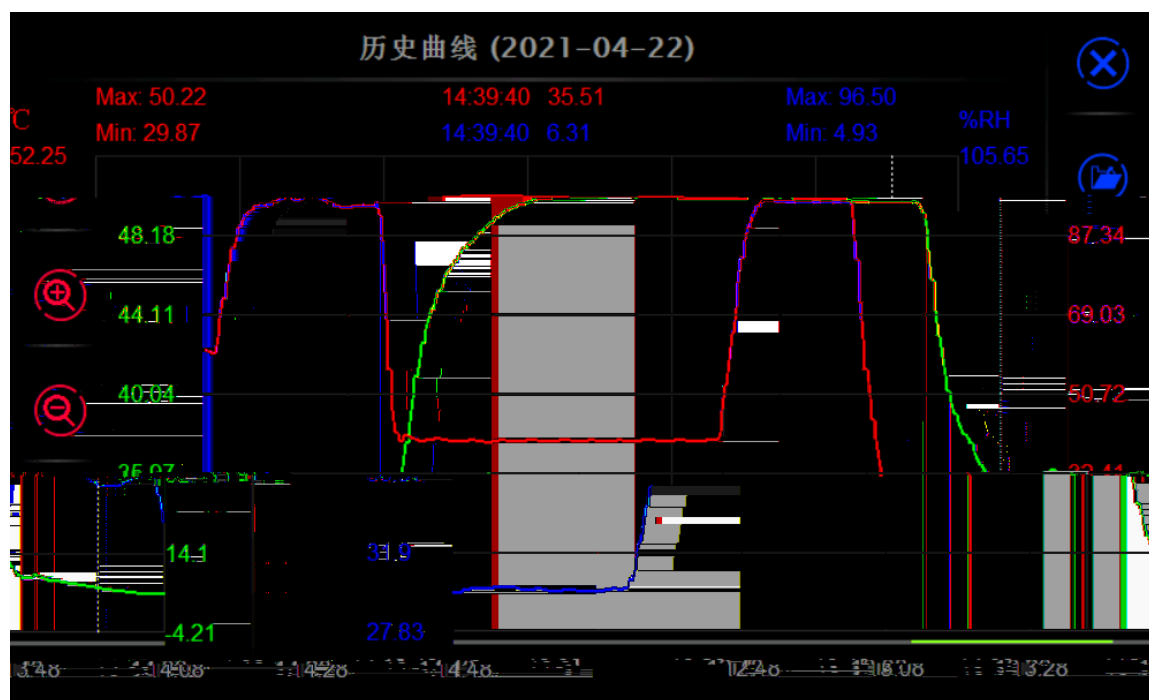

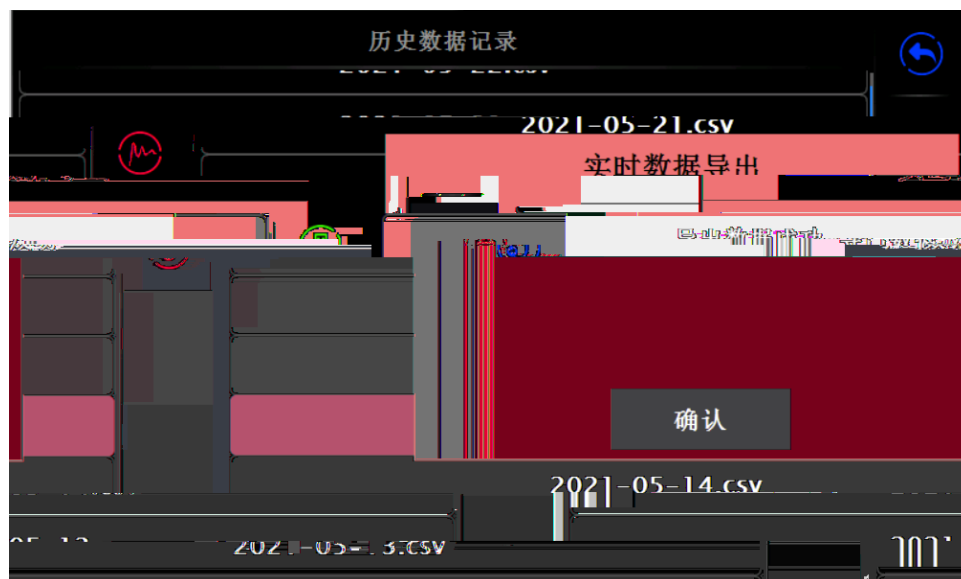

1

2

3

4

5

6

7

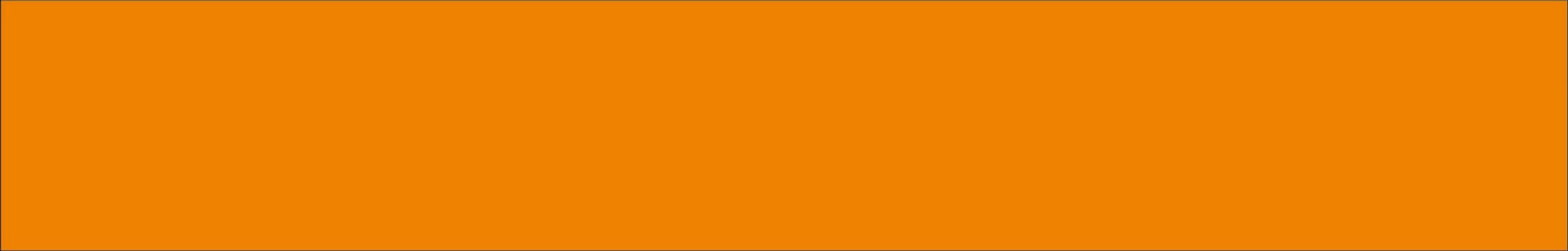

北京康斯特仪表科技股份有限公司